



NIC.br Infra-estrutura do ISP SP Access Platforms

Adalberto Lins
Adalberto@cisco.com

Tendências no Mundo Digital



Mais Dados

8GB

De tráfego Internet por mês de PCs e tablets em 2021*

Mais Dispositivos

6.1B

Usuários de smartphones no mundo em 2020***

Mais Apps

20-50%

Aumento de banda nas empresas por ano até 2018**

* Cisco Visual Networking Index

**US The Census Bureau of the Department of Commerce, 2015

*** Ericsson mobility report - <http://www.ericsson.com/ericsson-mobility-report>

Forte Preferência de Contratar do Provedor

- Network Service Provider
- Direct from Vendor
- Value Added Reseller
- Local Consultant
- Don't want Managed
- Don't Know

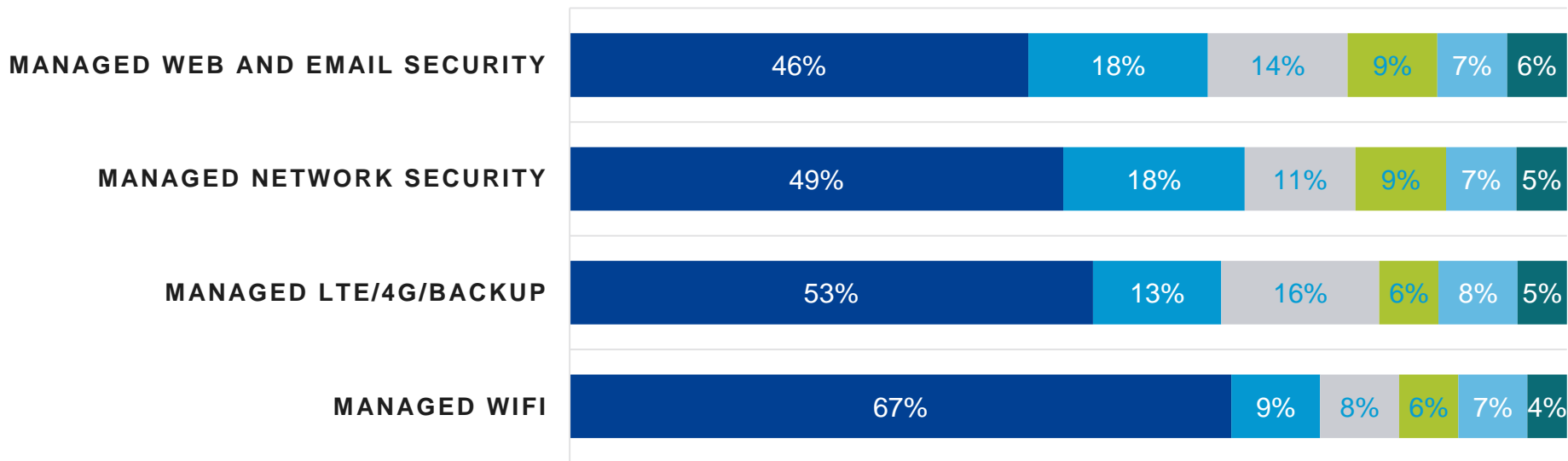

SMBs querem comprar Serviços Gerenciados do provedor de rede.
Menos de 10% não quer uma solução gerenciada.

Capturando Essa Oportunidade...

Aumento da Margem

Com mais oferta de SVA



Eficiência Operacional

Aproveitando a automação da nuvem



Simplicidade/ Melhor Experiência

Reduzindo o custo de aquisição, operação



Lealdade

Redução da perda de clientes



- Mais de 50% dos SMBs comprariam SVAs do provedor de rede
- 75% dos clientes mudariam de provedor caso este não oferecesse serviço gerenciado baseado em nuvem

Large Telecom Service Provider Access Portfolio

Service Provider Access Portfolio

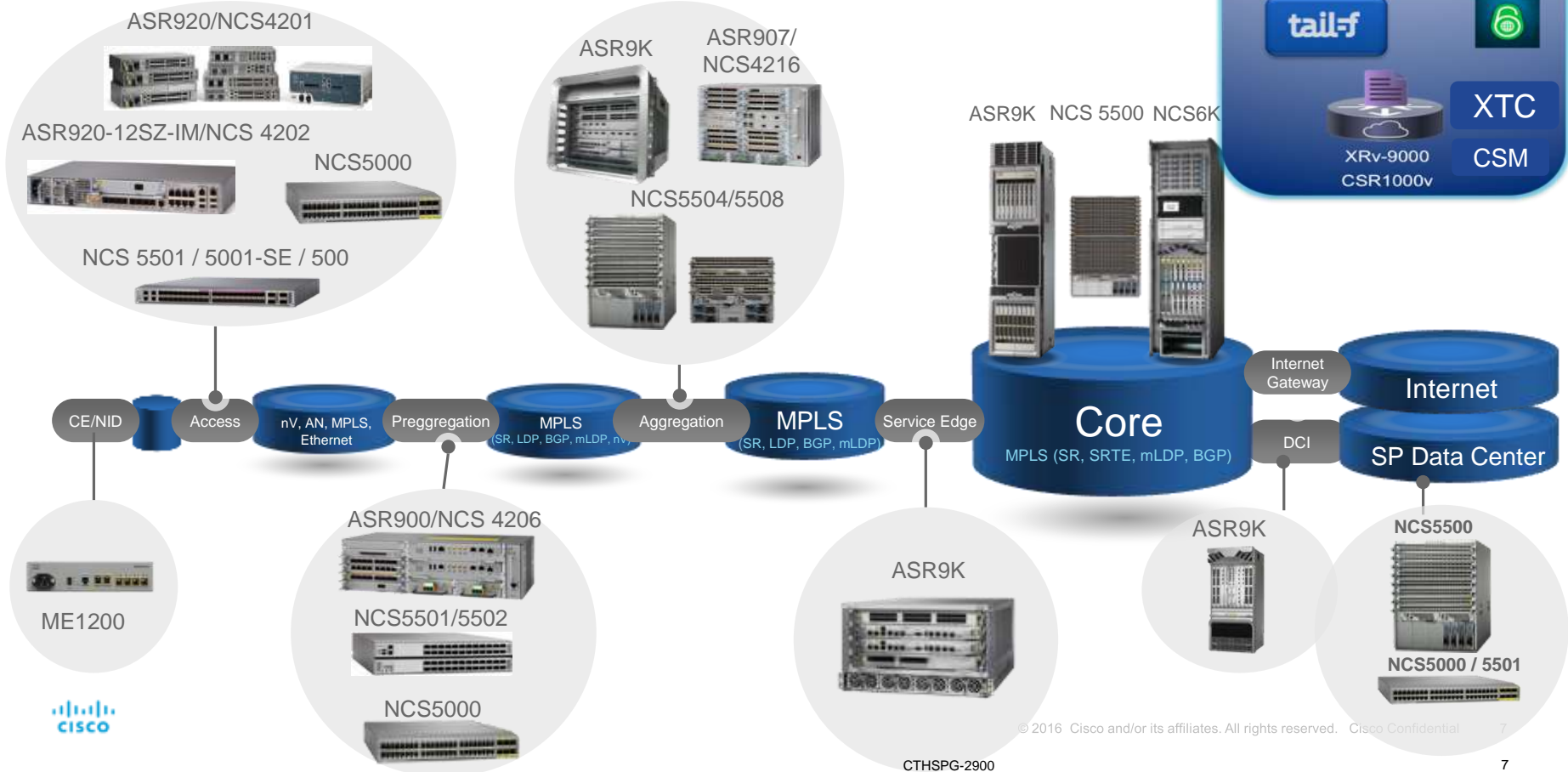

Trends: New Opportunities

The world has gone mobile

Changing Customer Expectations With AI, VR



8X Mobile Traffic Growth
From 2015-2020

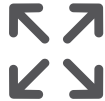

Ubiquitous Access
to Apps & Services

Traffic growth in Access, driven by video

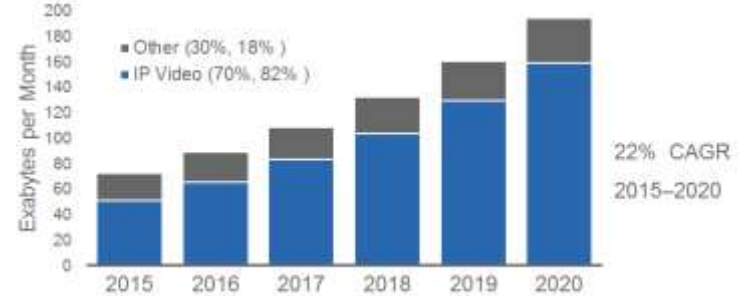

Rise of cloud computing

Soon to Change SP Architectures/ Service Delivery



Changing Enterprise Business Models
Efficiency & Capacity

Digitization leading to IoE

Emergence of the Internet of Everything



People



Process



Data



Things

Market Trend: Network Infrastructure Convergence

Single Any-Service Network for Lower CAPEX & OPEX

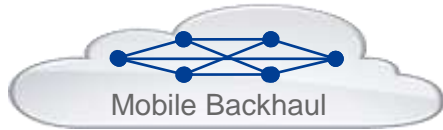

Multiple under-utilized networks
No integration between services
Different operational skill sets



Decoupled Service from Infrastructure

- One efficiently utilized network
- One operational model
- All services on a single network

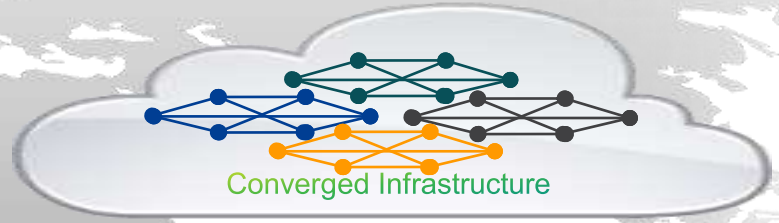

Convergence Benefits

- Up to 75% CAPEX savings
- OPEX efficiency – one skill set
- Revenue opportunities – one access, multiple services

Referencia Regional Service Provider Access Portfolio

Topologia de Referência

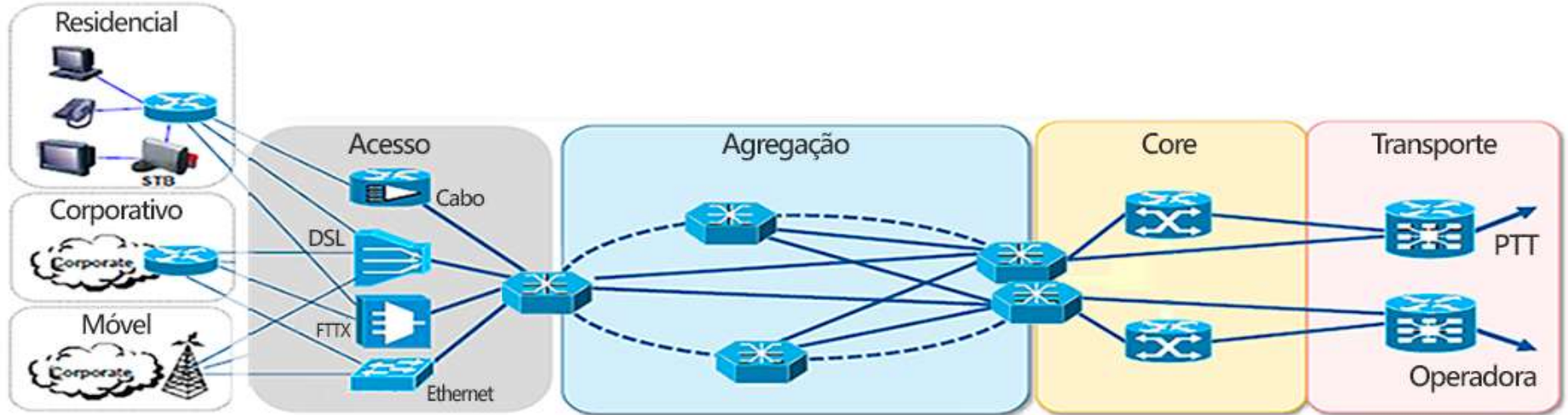

CPE
WiFi
SD WAN
Security
IPv6

FTTH, PON
GPON, STP,
REP, 802.1Q
Etc,

OSPF, MPLS,
VPLS, L3VPN

Segment Routing
BGP-eVPN

BGP, PPPoE,
CGNAT, IPoE,

NAT64

BGP
BGP Full
IPv4/IPv6

CPE

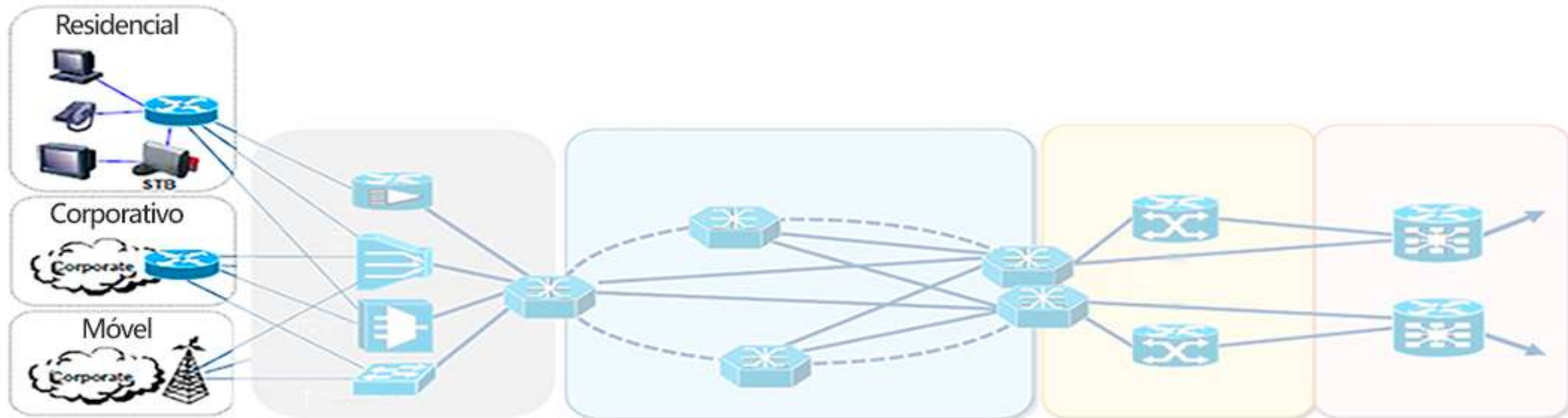

ISR 1000



cisco Meraki



Cisco Enterprise Routing Portfolio

Cloud



CSR 1000V

- 10 Mbps to 10 Gbps
- DNA Virtualization
- Extend enterprise routing, security and management to cloud

vEdge Cloud

- 10 Mbps to 100 Mbps
- Extend overlay to public cloud

Branch

ISR 800



- Up to 100 Mbps
- Fixed and fanless
- Enterprise-class branch routing with security

ISR 1000



- Up to 250 Mbps
- Fixed and fanless
- Integrated wired and wireless access

vEdge 100



- 100 Mbps
- 4G LTE & Wireless

ISR 4000



- Up to 2 Gbps
- Modular
- Integrated container applications
- Compute with UCS E

vEdge 1000



- Up to 1 Gbps
- Fixed

WAN Edge

ASR 1000



- 2.5-200Gbps
- High-performance service with hardware assist
- Hardware and software redundancy

vEdge 2000



- 10 Gbps
- Modular

Virtual



- 50 Mbps to 2.5 Gbps
- Virtual enterprise-class networking
- Run on x86 compute platform
- ENFV orchestration & management

Cisco ENCS



- Service chaining virtual functions
- Modular WAN connectivity
- Open for 3rd party services & apps

Cisco 1000 Series Integrated Services Routers

Foundation for the digital branch

WAN and Application Assurance

IWAN App over APIC-EM and DNA-C
Application Visibility and Link Optimization
VPN and Security

Advanced Mobility

LTE Advanced
Mobility Express

High Performance

High WAN-WAN and LAN-WAN performance
High Performance VPN and Security

Proactive Security

Secure connectivity
Branch threat defense
Visibility and analytics



Physical

Cisco 1100
Integrated
Services Router



Connectivity

Ethernet

xDSL

LTE
Advanced

801.11ac
Wave 2

Manageability

APIC-EM

WebUI

Prime

DNA Center

Cisco 1000 Series Integrated Services Routers

Value and Benefits



Speed and Performance

Multi-core hardware architecture

Open and programmable operating system IOS® XE

Trustworthy Systems



Connectivity

Ethernet, DSL, LTE Advanced,

Gigabit Ethernet LAN

802.11ac wave2 with Mobility Express



Ease of Use

Centralized management and orchestration with Cisco DNA Center

Zero touch deployment and provisioning



Comprehensive Security

Advanced threat defense with encryption at high-performance

Umbrella Branch provides secure WAN and enterprise-class security.

Encrypted Traffic Analytics using machine learning for anomaly detection

Acesso

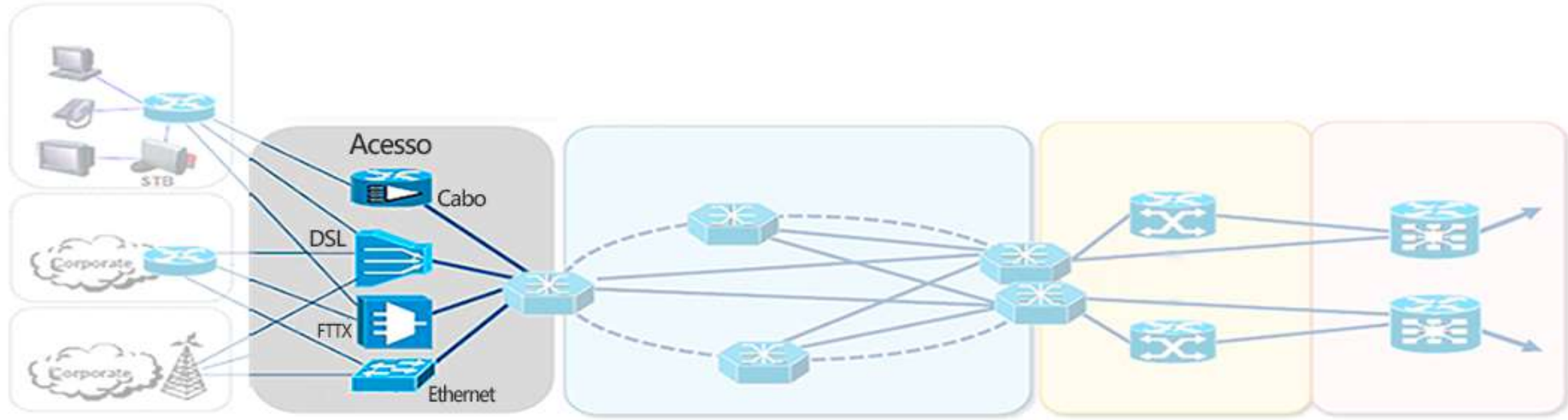

ASR920



NCS 540



ASR 903



ASR 907

Cisco ASR 920 Portfolio



	ASR-920-4SZ-A/ASR-920-4SZ-D	ASR-920-12CZ-A/ASR-920-12CZ-D	ASR-920-10SZ-PD	ASR-920-24TZ-M	ASR-920-24SZ-M	ASR-920-24SZ-IM	ASR-920-12SZ-IM
Size	1RU	1RU	2-4RU	1RU	1RU	1.5RU	1RU
IM Slots	-	-	-	-	-	1	1
Air Flow	Front to Back	Front to Back	-	Front to Back	Front to Back	Front to Back/Side to Back	Front to Back
1G ports	2/6	12/14	10	24	24	24	12/16
10G ports	4	2	2	4	4	4	4

ASR 920 Series



Secured Cell Site Router

12xGE + 4x10GE

Full line rate

One modular slot

-40C to 65C, < 300mm depth

IPSec, GPS. PoE support

Redundant and modular PS: AC and DC

High Density Model

Up to 24xGE + 4x10GE

Full line rate

Fixed or one modular slot

-40C to 65C, < 300mm depth

SyncE/1588/BITS

Redundant and modular PS: AC and DC

Low Density Models

Up to 12xGE and 2x10GE

Full line rate

-40C to 65C, < 300mm depth

Passively cooled model available

SyncE/1588/BITS

Fixed redundant PS: AC and DC

Premium fixed access routers for Carrier Ethernet, Mobile Backhaul, or Fiber to the Home Deployment. Single ASIC and OS across portfolio

Cisco ASR 920 Foundational Pillars

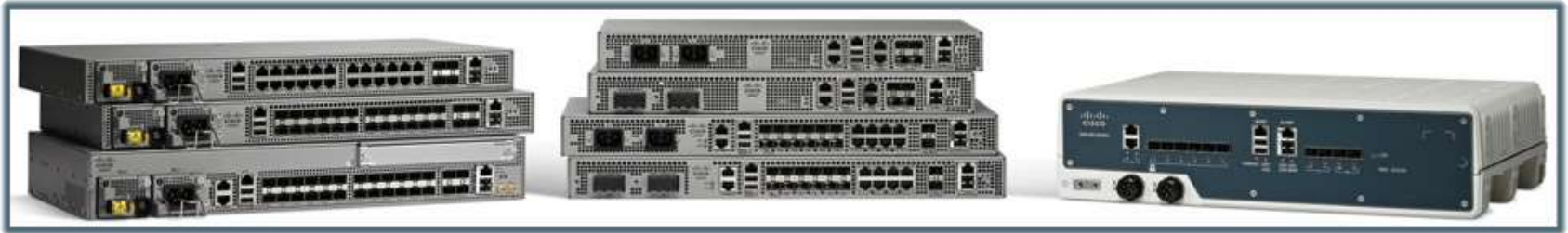

- **Sharing Single OS, Single ASIC:** Optimize network operations and manageability
- **Breadth of product portfolio:** Multiple product variants - Indoor and Outdoor
- **Compact:** Small form-factor and temperature hardened platforms
- **Advanced Carrier Ethernet & MBH DNA:** Single converged platform running on same OS and ASIC addressing needs of both CE and MBH
- **Enables Network Convergence** of Business & Residential Services for both Fixed & Mobile Networks

ASR 900 Chassis



ASR 902 (2RU)

Single Route Switch Processor

4 interface module slots

480G backplane capacity

I-Temp -40C to 65C, < 300mm depth

Redundant and modular PS AC and DC



ASR 903 (3RU)

Dual Route Switch Processor

6 interface module slots

480G backplane capacity

I-Temp -40C to 65C, < 300mm depth

Redundant and modular PS AC and DC

50 msec ISSU support



ASR 907 (7RU)

Dual Route Switch Processor

16 interface module slots

2T backplane capacity

I-Temp -40C to 65C, < 300mm depth

Redundant and modular PS AC and DC

50 msec ISSU support

Compact , Redundant, and High Capacity Small Aggregation Platforms with Flexible Interface Support

Agregação

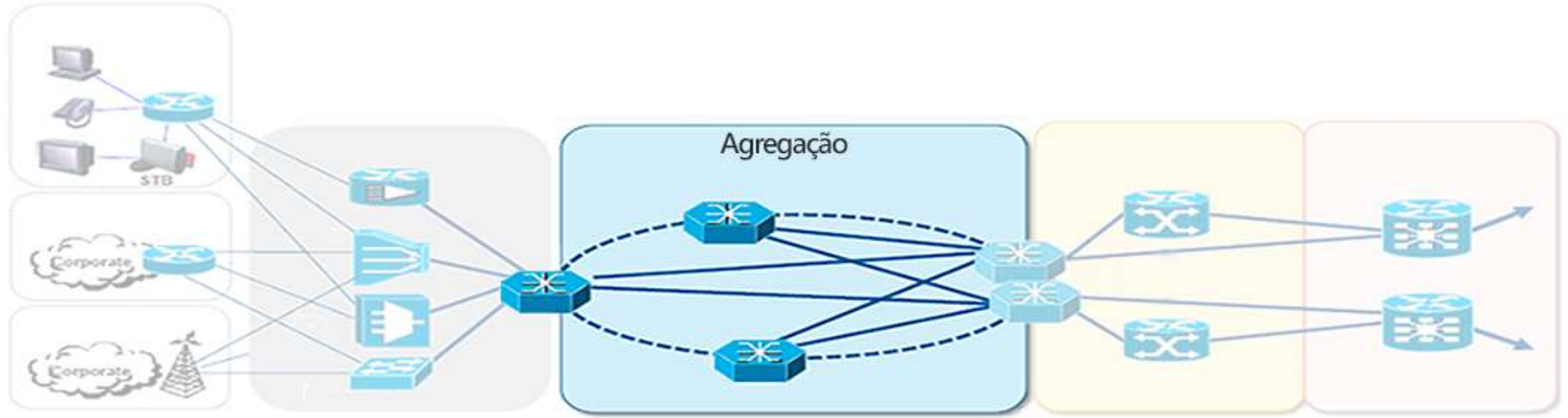

ASR920



NCS 540



NCS5000 /
NCS5500

IOS XR Family



Virtual RR/PE/DC Forwarder

Cisco IOS-XRv 9000



Cisco NCS 5500 & NCS 5000



Cisco ASR 9000, CRS & NCS 6000

OPTIMIZED Cisco vXR Software



Elastic



Cost Optimized



Ultra-high Density



Carrier Grade



Programmability and Automation

NCS 5500 Product Family

100G-optimized, Scalable IOS XR Routers



NCS 5501

800 Gbps – 1 RU



NCS 5502

4.8 Tbps – 2 RU



NCS 5504

14.4 Tbps – 7 RU



NCS 5508

28.8 Tbps – 13 RU



NCS 5516

57.6 Tbps – 21 RU

Platforms Comparison

Scale Chart

	NCS 5501	NCS 5501-SE	NCS 5502/-SE	NCS 5508	NCS 5516	NCS 55A1-36H	NCS 5001	NCS 5002	NCS 5011
10G	48+6x4	40+4x4	48x4	8x36x4	16x36x4	36x4	40+4x4	80+4x4	32x4
40G	6	4	48	8x36	16x36	36	4	4	32
100G	6	4	48	8x36	16x36	36	4	4	32
BW Gbps	800	800	4,800	28,800	57,600	3,6000	800	960	3,200
Total Mpps	720	600	5,760*	34,560	69,120	3,340	1,440	1,440	?
Power W	240	320	1,850*	6,940	14,750	1,300	200	300	228
Pfx scale	1.1M+	2.75M	Up to 2.75M IPv4			Up to 8M	128k IPv4 + 16k MPLS		
Buffer	4GB per Forwarding ASIC						16MB		
Queues	96k						2,960	1,280	

CORE

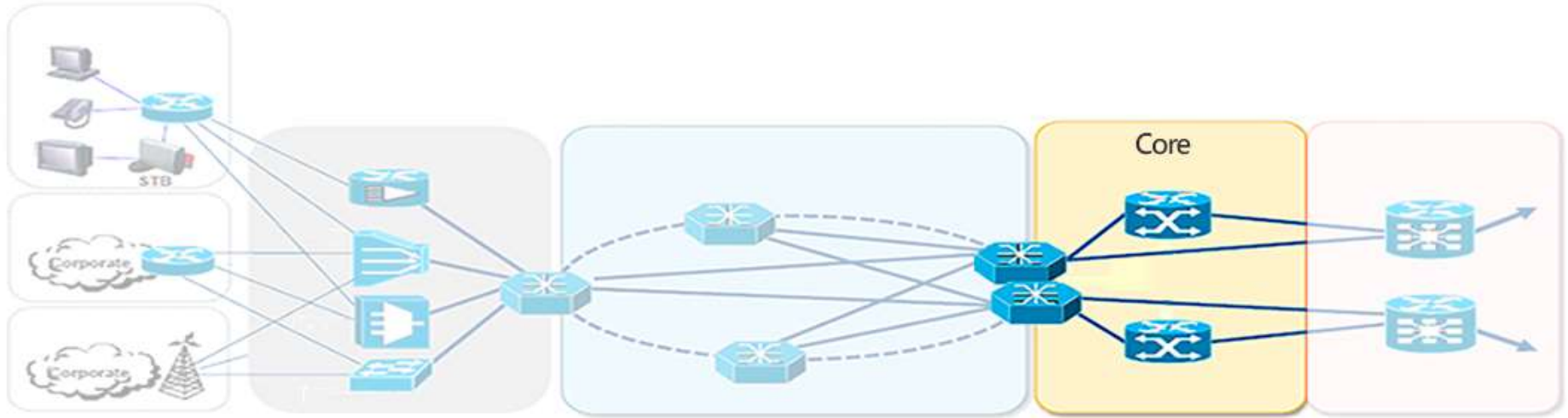

ASR1001/
ASR1002



ASR1001 HX
ASR1002 HX



ASR9001 /
ASR9901

The Cisco ASR 1000 Series Router Family

▶ Compact,
Powerful Router

▶ Business-Critical
Resiliency

▶ Instant-On
Service Delivery

Fixed Chassis

IOS-XE

Modular Chassis

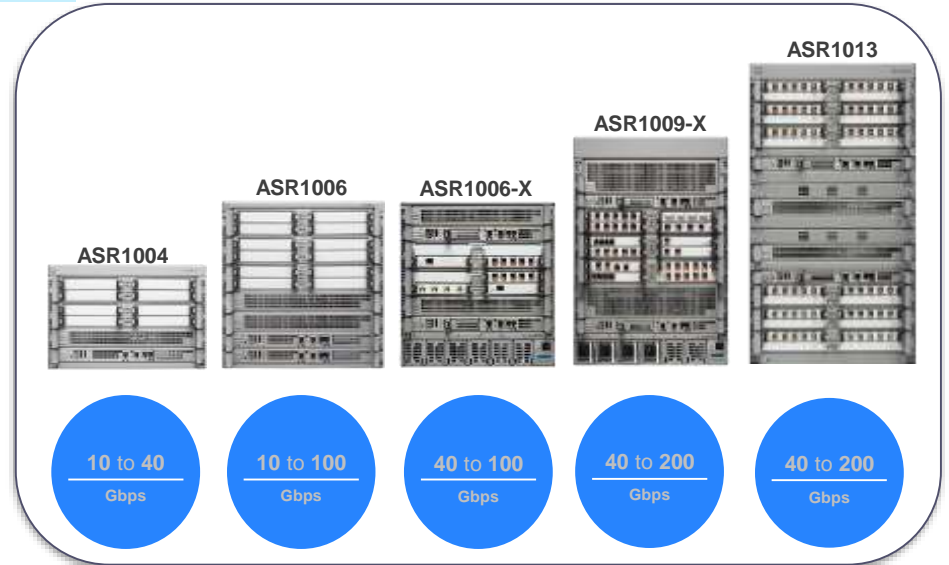
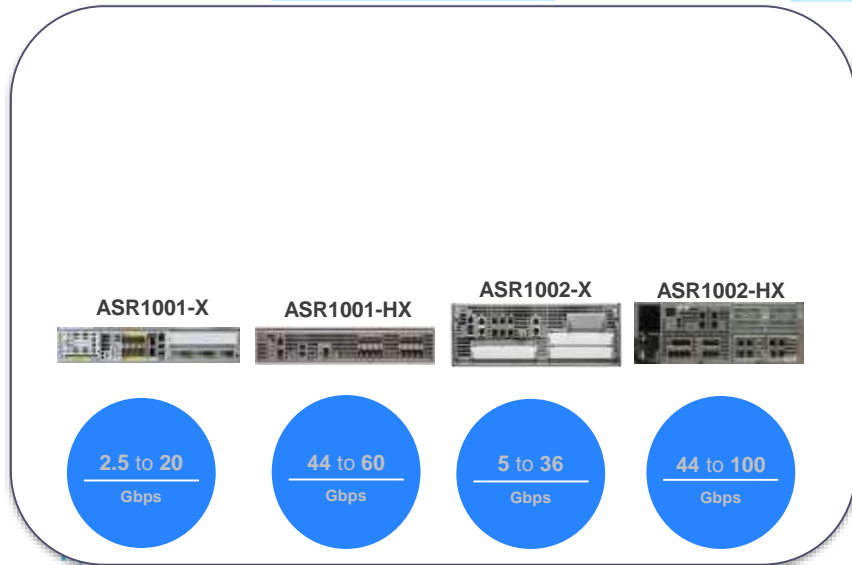

ASR 1000 Series Momentum

Customer Adoption

- 44,500+ customers (SP + ENT)
- 300,000+ chassis sold

Feature Velocity & Adoption

- 28 major releases since FCS in May 2008
- Over 3,000 features to support many solutions
 - SD-WAN, SD-Access, DNA, VPN, DCI, Segment Routing, Programmability, etc.

of Features

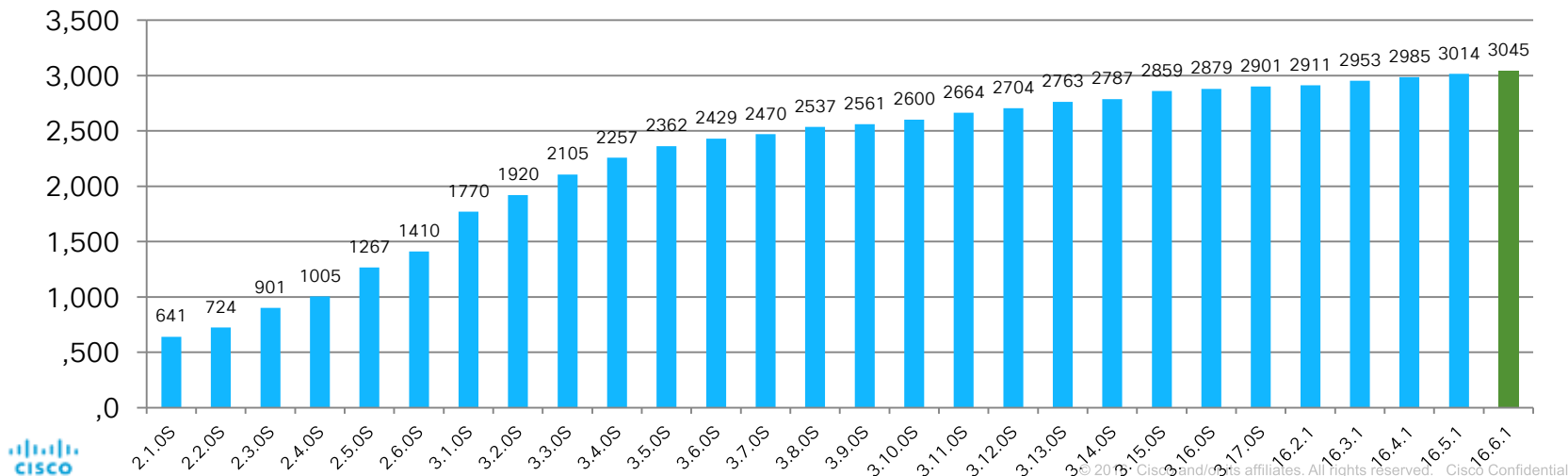

Cisco ASR9000/ASR9900 Portfolio

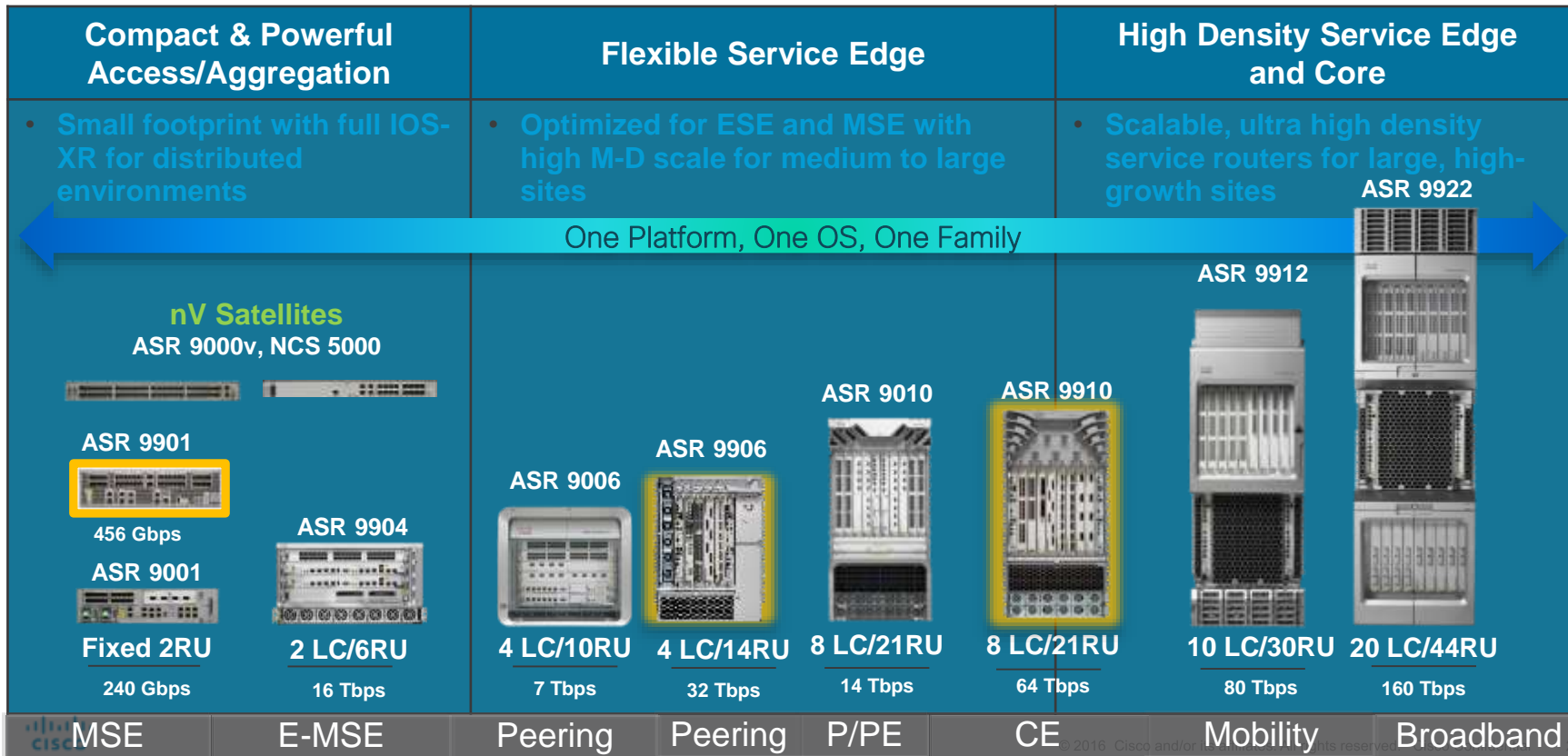

Transporte

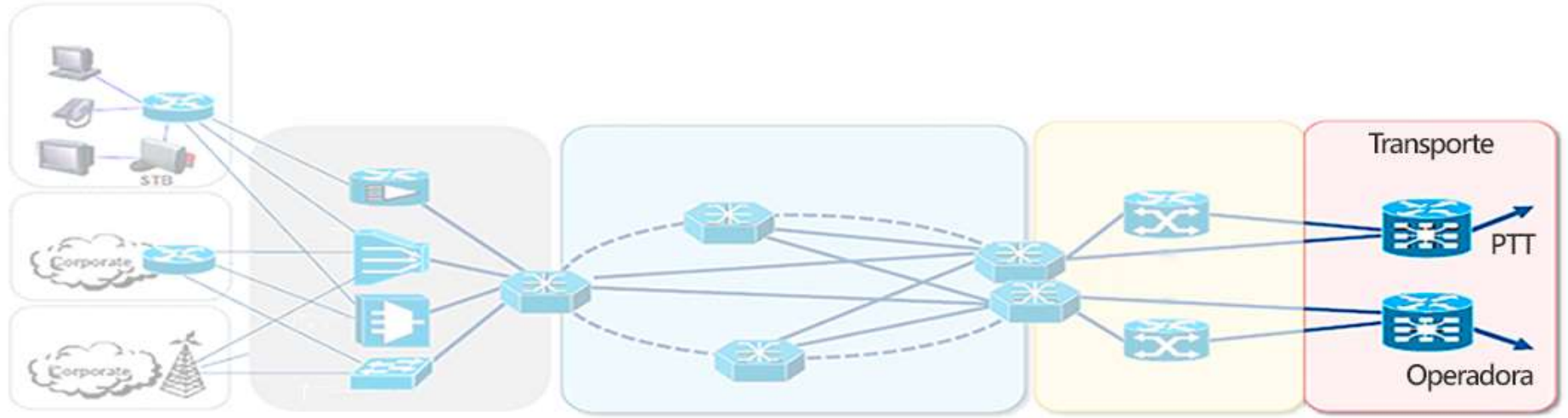

NCS5500-SE



ISR-4k



ASR9000 /
ASR9900



ASR-1k

Pay-As-You-Grow with Cisco ISR 4000 Series

Investment Protection Without Oversubscription

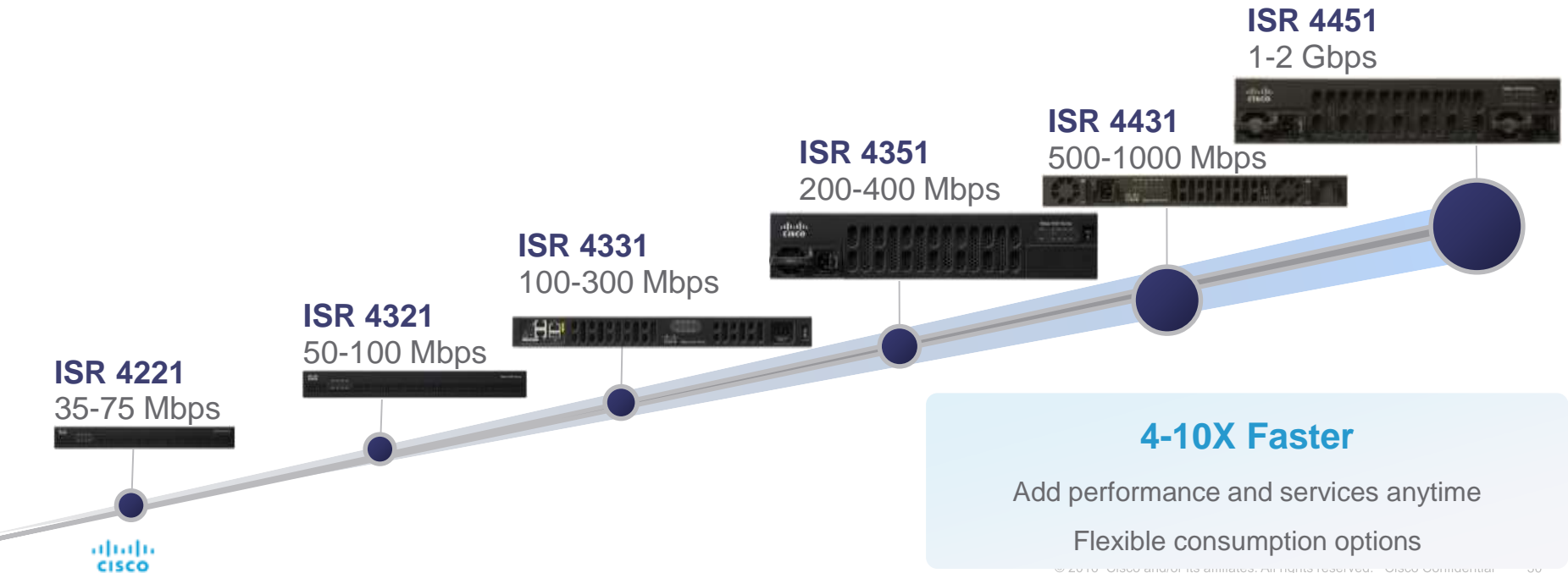

ISR4K Specifications Summary

Platform	Performance	Height	GE / RJ45 / SFP	NIM	SM-X / DW	Default / Max Memory	Default / Max Flash Memory	RPS
ISR 4451	1 – 2 Gbps	2RU	4/4/4	3	2 / 1	4GB / 16GB	8GB / 32GB	Yes
ISR 4431	500 – 1000 Mbps	1RU	4/4/4	3	0	4GB / 16GB	8GB / 32GB	Yes
ISR 4351	200 – 400 Mbps	2RU	3/3/3	3	2 / 1	4GB / 16GB	4GB / 16GB	No
ISR 4331	100 – 300 Mbps	1RU	3/2/2	2	1 / 0	4GB / 16GB	4GB / 16GB	No
ISR 4321	50 – 100 Mbps	1RU	2/2/1	2	0	4GB / 8GB	4GB / 8GB	No

Exemplos de Topologia

Service Provider Portfolio (P)

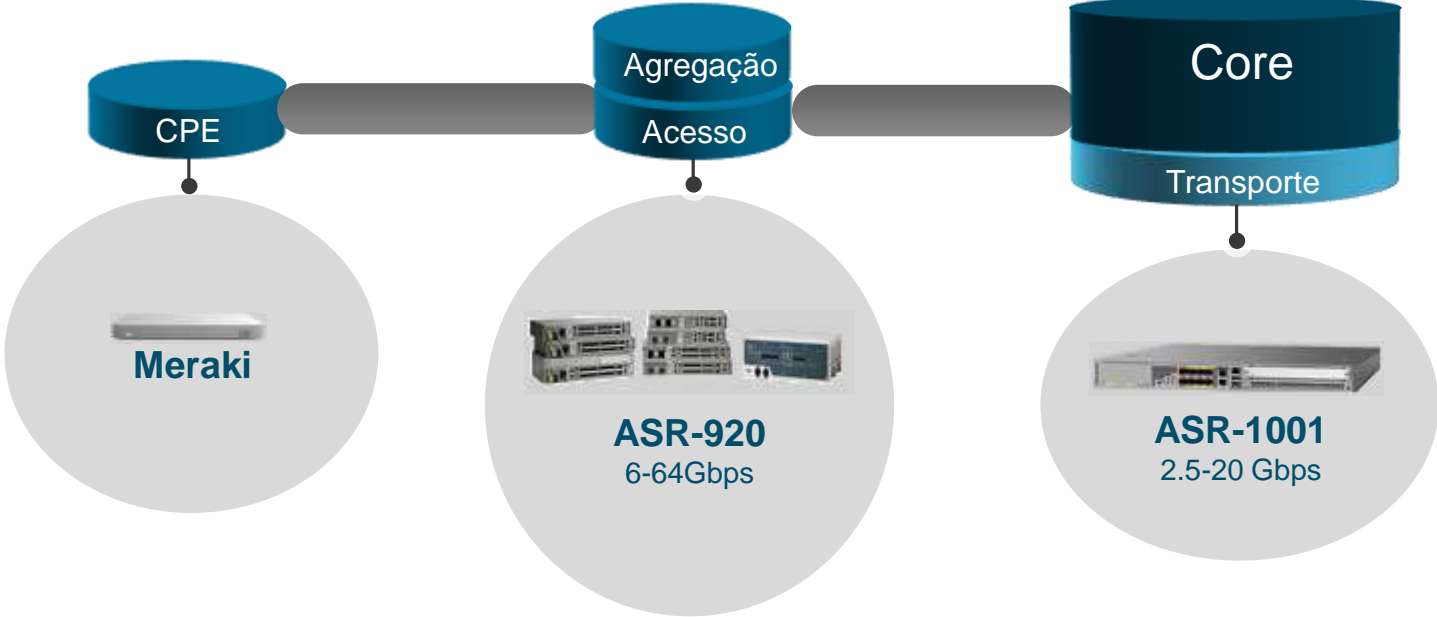

Service Provider Portfolio (P1)

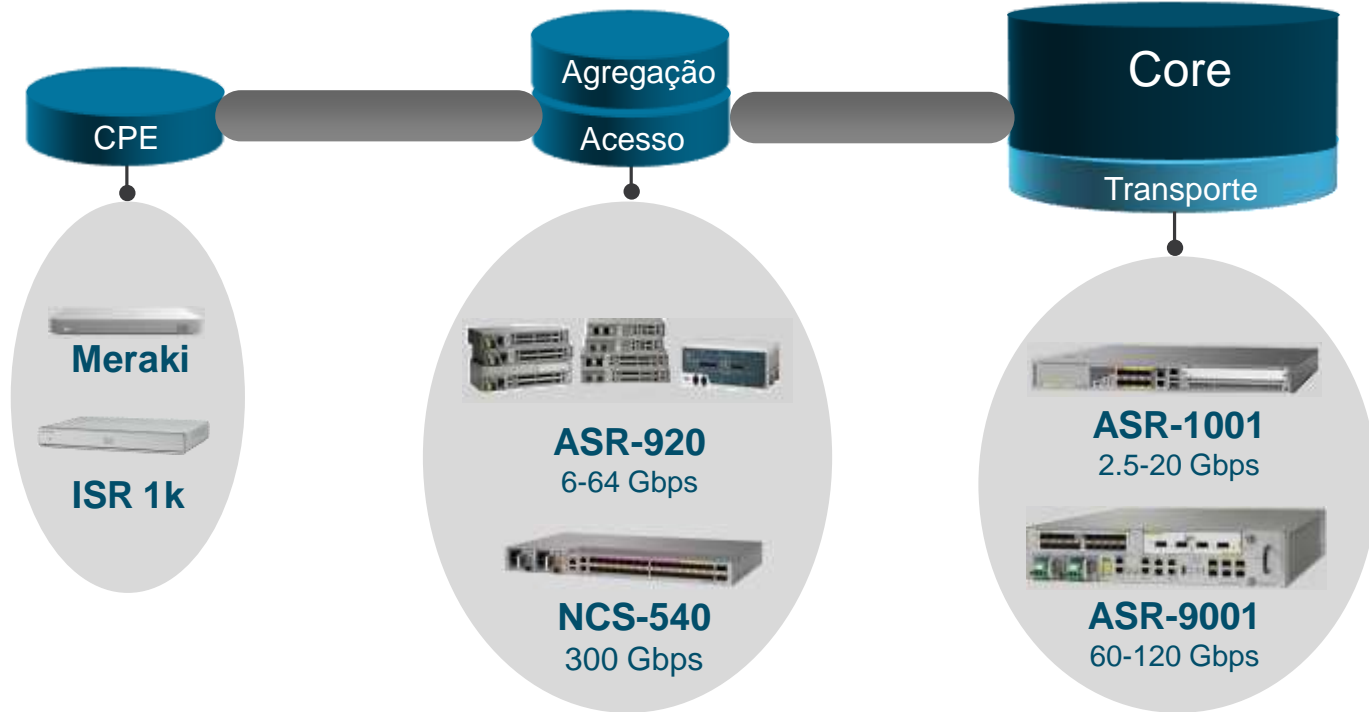

Service Provider Portfolio (M)

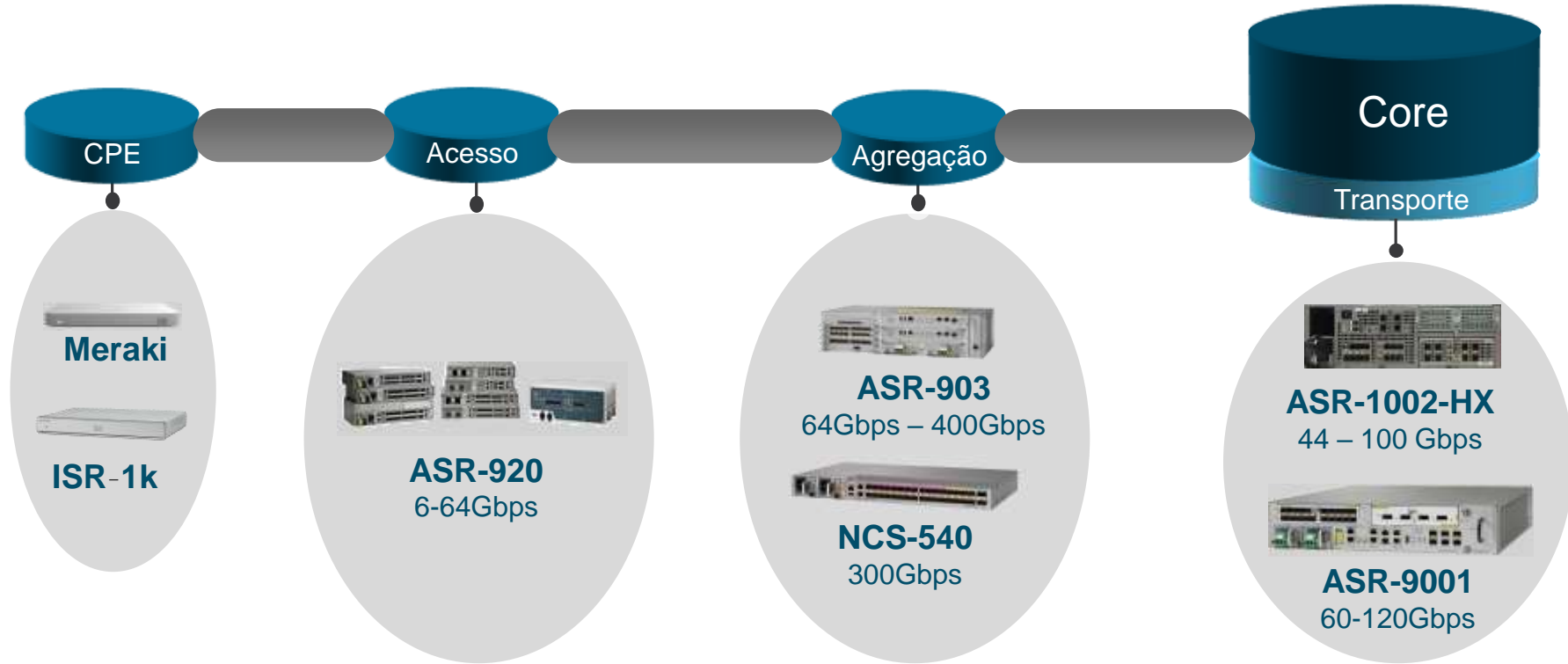

Service Provider Portfolio (M1)

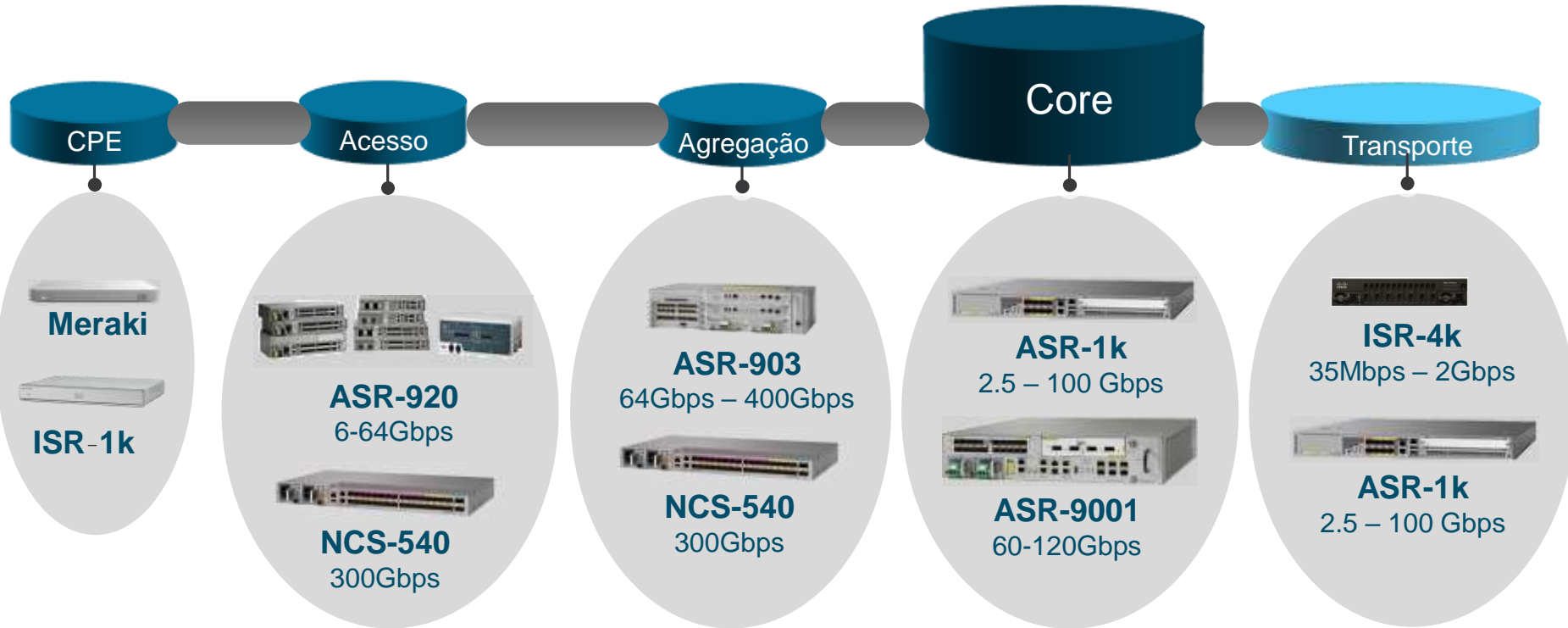

Service Provider Portfolio (G)

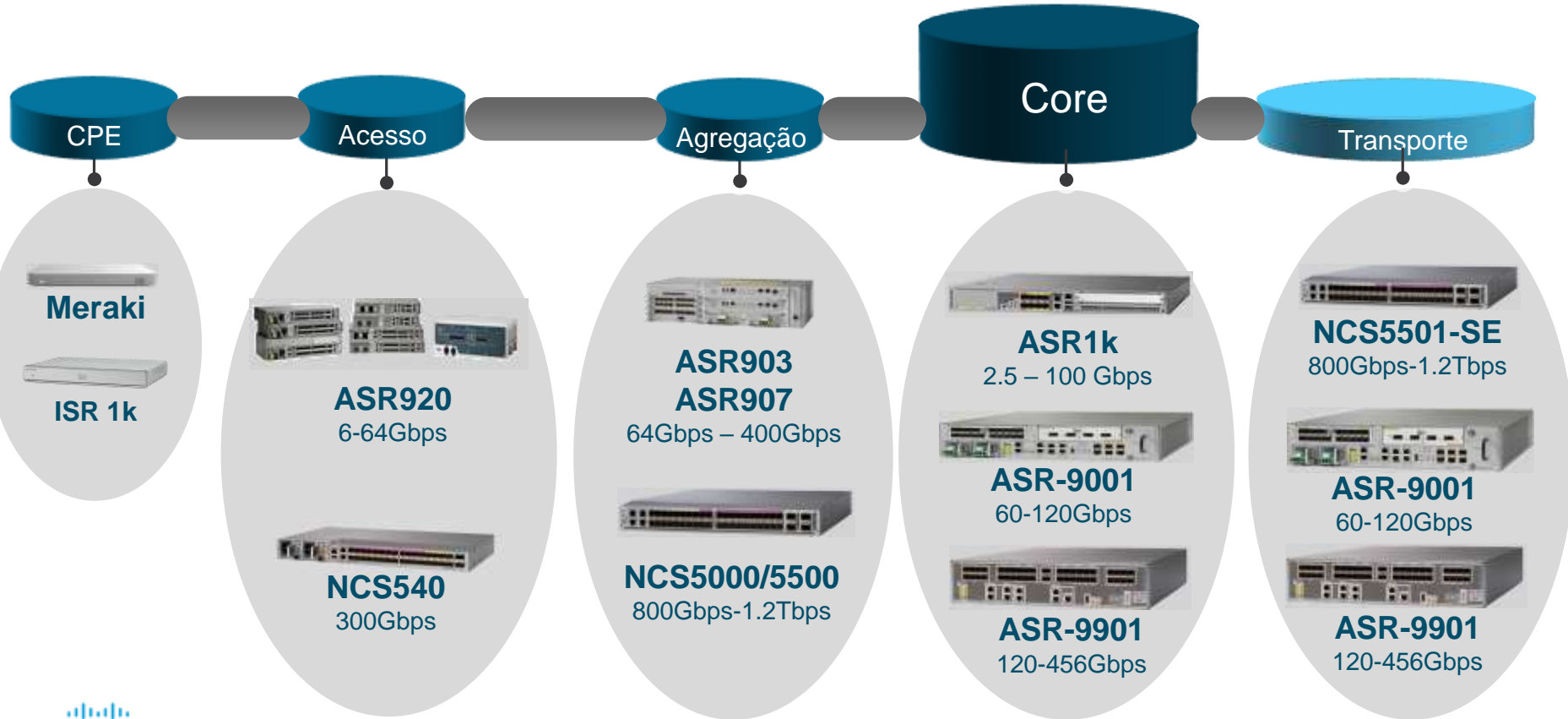

Novidade: NCS 540

NCS 540 Front & Back Details

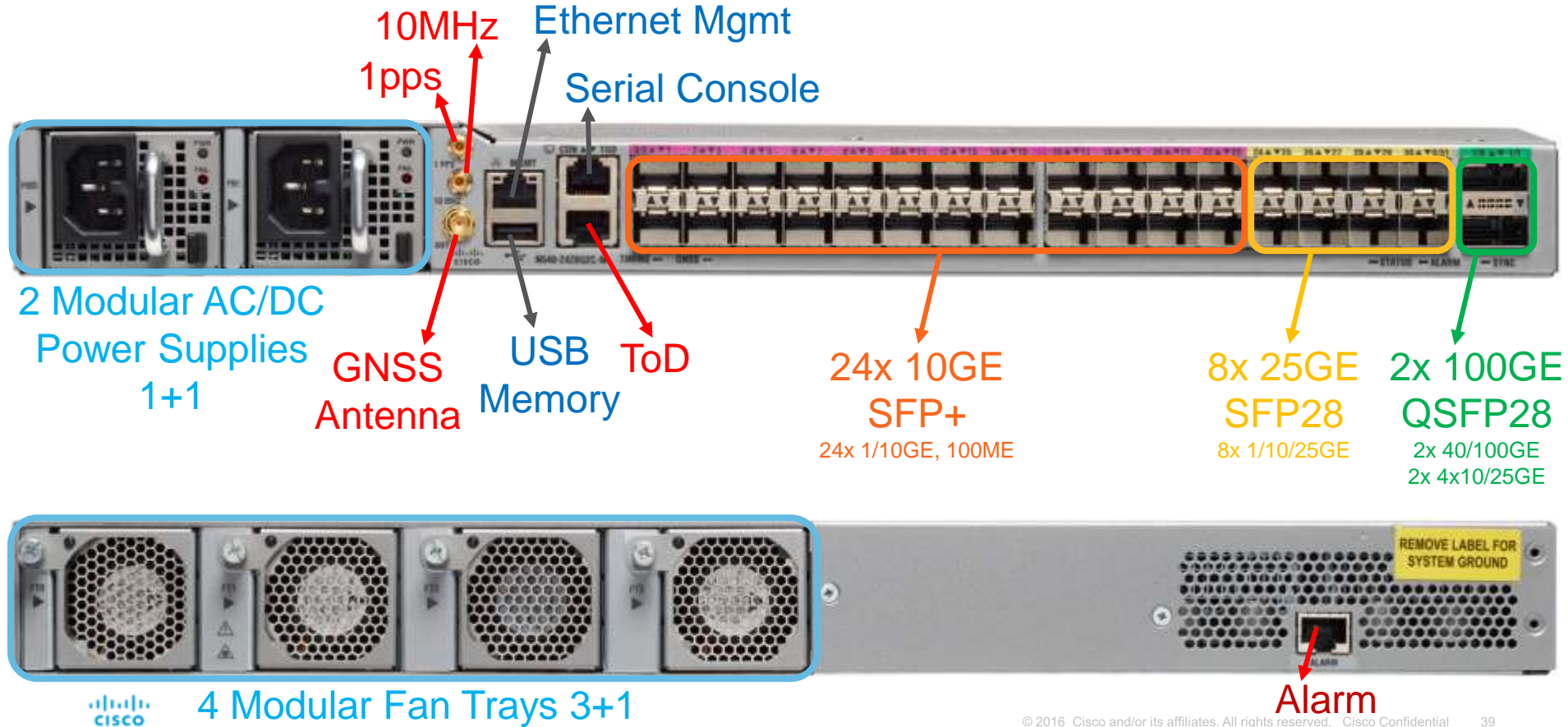

N540-24Z8Q2C-SYS

ASIC/CPU/Mem

- 300 Gbps BCOM, Intel Broadwell 4C 1.8GHz CPU
- 32GB RAM, 128G SSD

Port Config

- 24x1/10G SFP+, 8x 25G SFP28, 2x100G QSFP28
- DWDM/ZR support on all SFP+ interfaces

PSU/Fan

- Modular & redundant PSUs and fans
- Front to back airflow

Temp Range

- iTemp 40C to +70C
- Conformal coated SKU for hot humid conditions

Optics

- 1/10G: SR/LR/ER/ZR/DWDM
- 25G: SR/LR, 40G: SR/LR/ER, 100G: SR/LR/ER4L

Timing

- 1PPS in/out, 10Mhz in/out, ToD, Internal GNSS
- SyncE, G.8265.1, G.8275.1/2, Class B BC

Service Scale

- 256 L3VPN, 2K PWs

Software

- FCS 64 bit IOS XR 6.3.2
- Full SW feature parity with NCS 5500

Shipping



SFP+	SFP28	QSFP28
• 24 x GE	• 8 x GE	
• 24 x 10GE	• 8 x 10GE	• 8 x 10GE
	• 8 x 25GE	• 8 x 25GE
		• 2 x 40GE
		• 2 x 100GE

NCS 540 5G Readiness

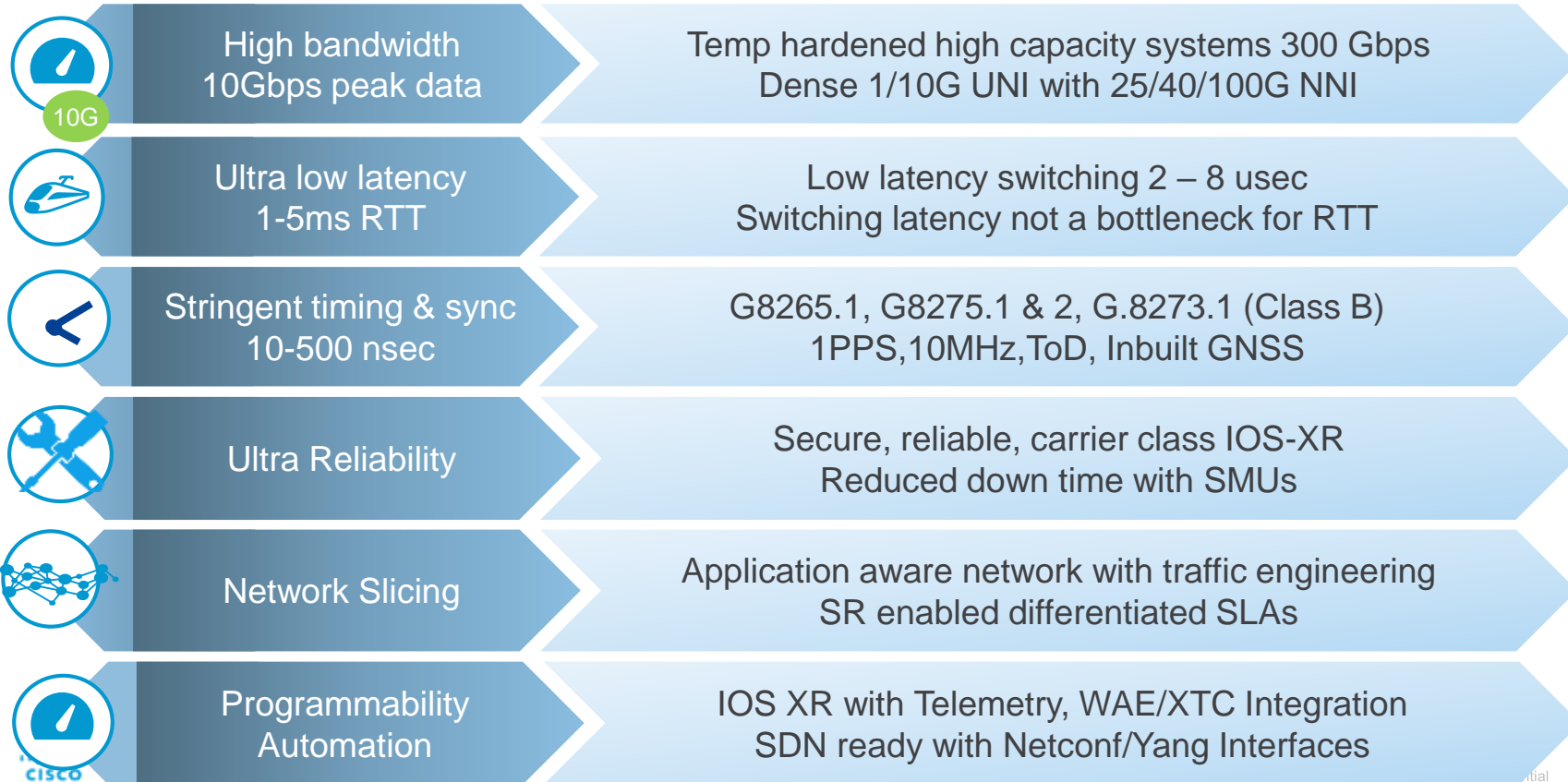

Novidade: ASR9901

ASR 9901 Highlights

NEW Mar'18
IOS XR 6.4.1



Form Factor & BW

- *2 RU box with 2 Tomahawk NPU (ASR 9001 is 2 RU with 2 Typhoons)*
- *Depth of ~23 inches,(9001 is 18")*
- *456G Duplex BW (9001 is 120G Duplex)*

Ports / Port Density

- *Fixed ports available; no MPAs*
- *42 ports on the faceplate : 16X1G, 24X1/10G, 2X100G(QSFP28)*
- *1G ports : LAN & MACSEC*
10G ports: LAN & MACSEC
100G port : LAN & MACSEC

SW & Licensing

- *64 bit XR only*
- *PAYG mode for 120G, 256G and 456G*
- *Full feature parity with Tomahawk feature-set*

Mechanicals & Commons

- *Redundant Power & Fan-trays*
- *Front to back Airflow*
- *NEBS, EMC Compliant*
- *All ports/power cabling on front plate; fan trays on backside*
- *Typical Power Consumed : 1200W*



ASR 9901 Port mapping

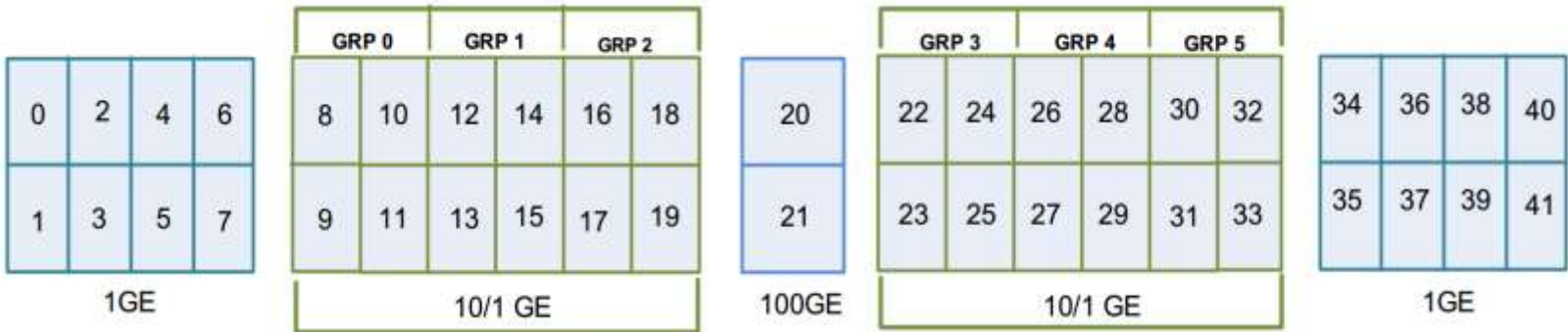

ASR-9901 Feature Roadmap

Phase	FCS	SW Feature Parity
1	Q3 FY18 (6.4.1) <i>(March 2018)</i>	General SW parity with Tomahawk feature-set for eXR (XR 6.3.1) in FCS release 6.4.1
2	Q4 FY18 (6.5.1) <i>(July 2018)</i>	<ul style="list-style-type: none">• BNG• Satellite• MAC-SEC (6.4.2)

Service Provider Access Portfolio

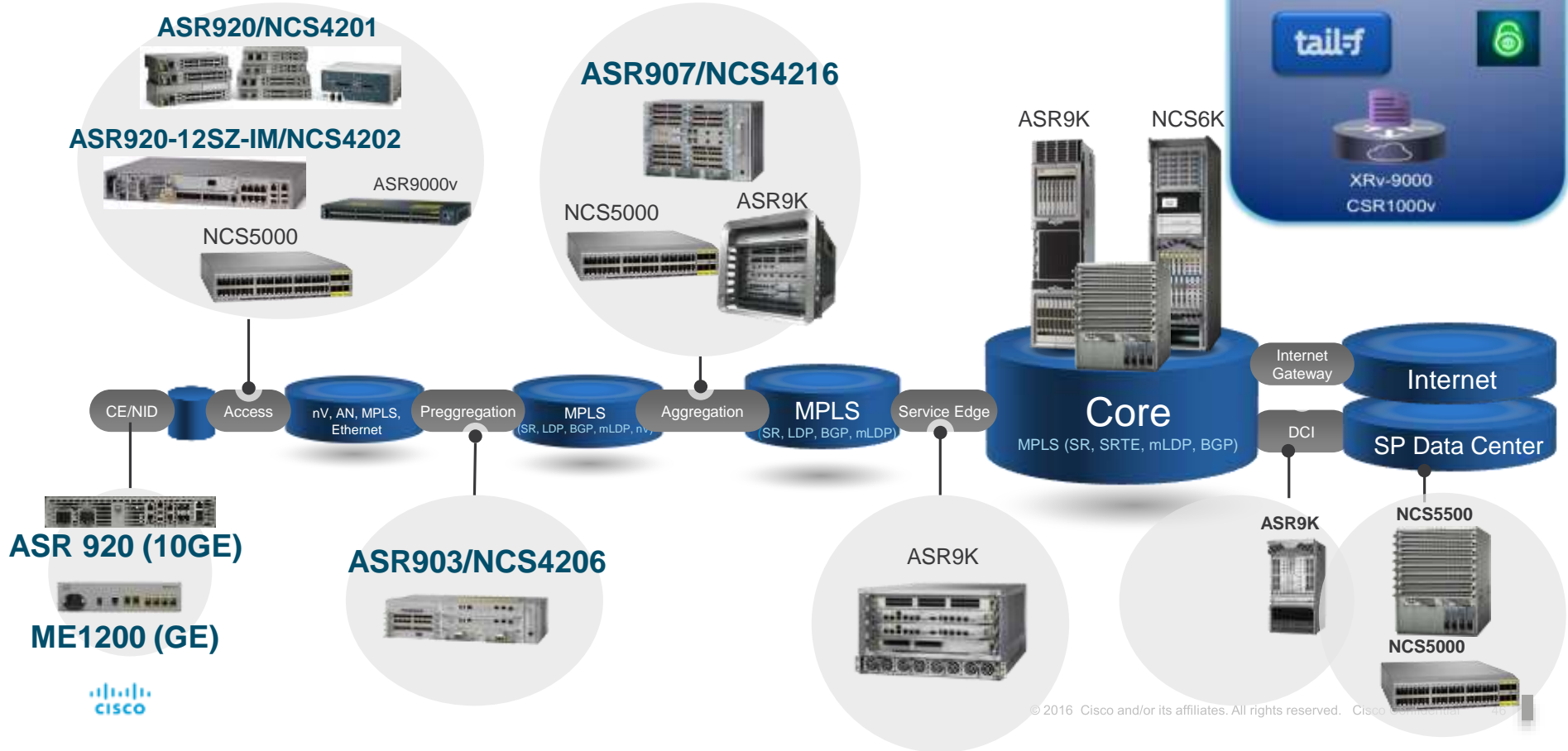

Service Provider Access Portfolio

ASR920/NCS4201



ASR920-12SZ-IM/NCS4202



ASR9000v

NCS5000

ASR907/NCS4216



NCS5000

ASR9000v

ASR9000v



VAMOS CHEGAR LÁ?



ASR 920 (GE)

ASR903/NCS4206



ME1200 (GE)

ASR9K



ASR9K



NCS5500



NCS5000



OBRIGADO !!!



Adalberto Lins
Adalberto@cisco.com

